



Sergio Mazzarella



# UN SECOLO DEL SETTORE AERONAUTICO CAMPANO

Una storia poco conosciuta

**D**libri  
Denaro libri





# Un Secolo del Settore Aeronautico Campano. Una storia poco conosciuta.



Un Secolo del Settore Aeronautico Campano.  
Una storia poco conosciuta.

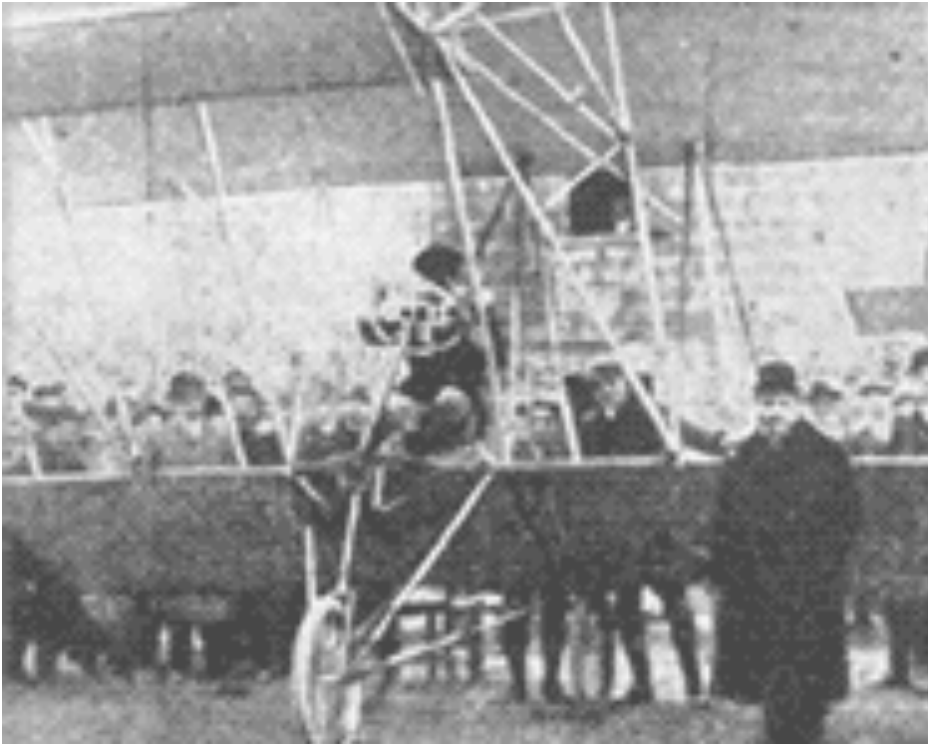

Giovanni Agusta  
Capua 1908



Un Secolo del Settore Aeronautico Campano.  
Una storia poco conosciuta.

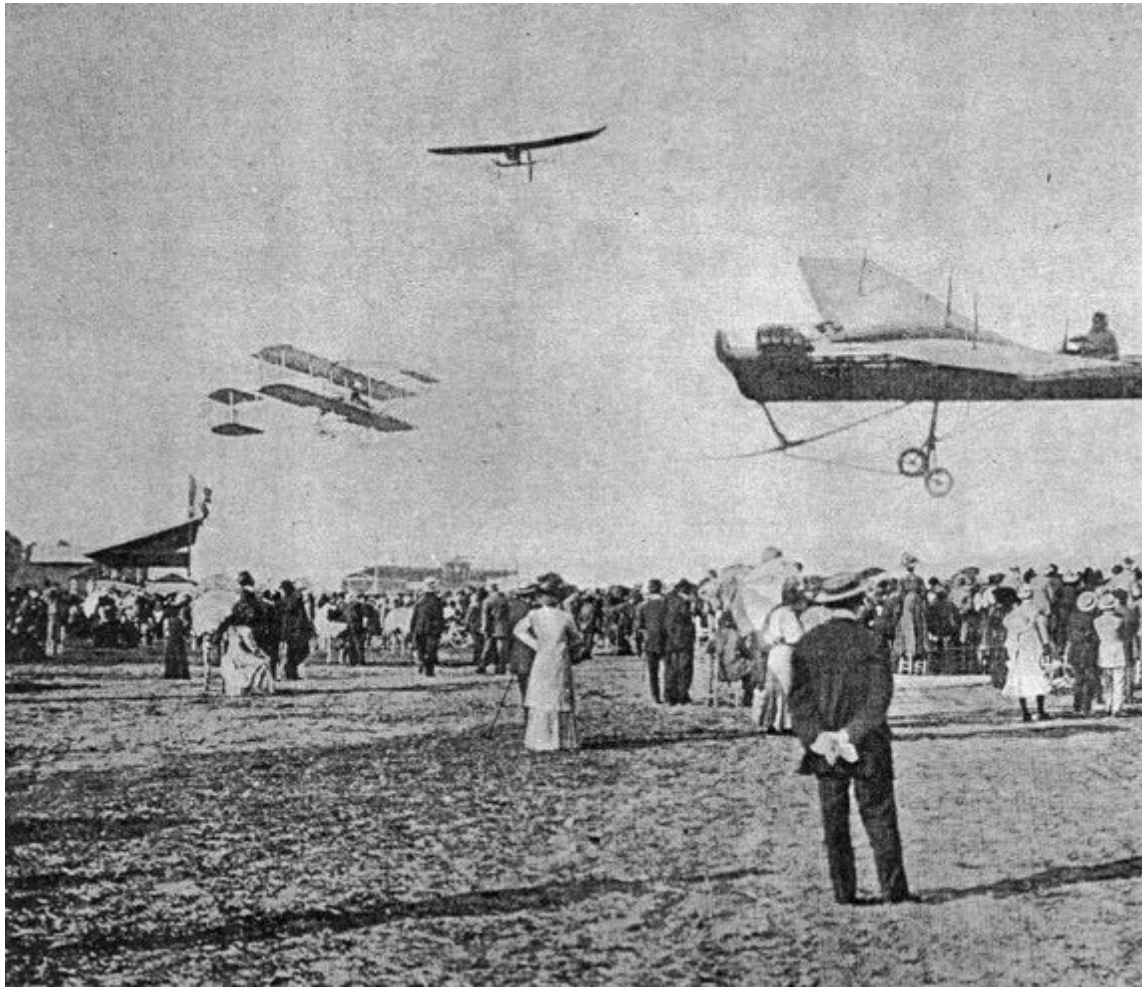

Prima manifestazione  
aerea

Circolo Aviatorio

Primo aereo

“ Napoli I° ”

Napoli 1910



Un Secolo del Settore Aeronautico Campano.  
Una storia poco conosciuta.

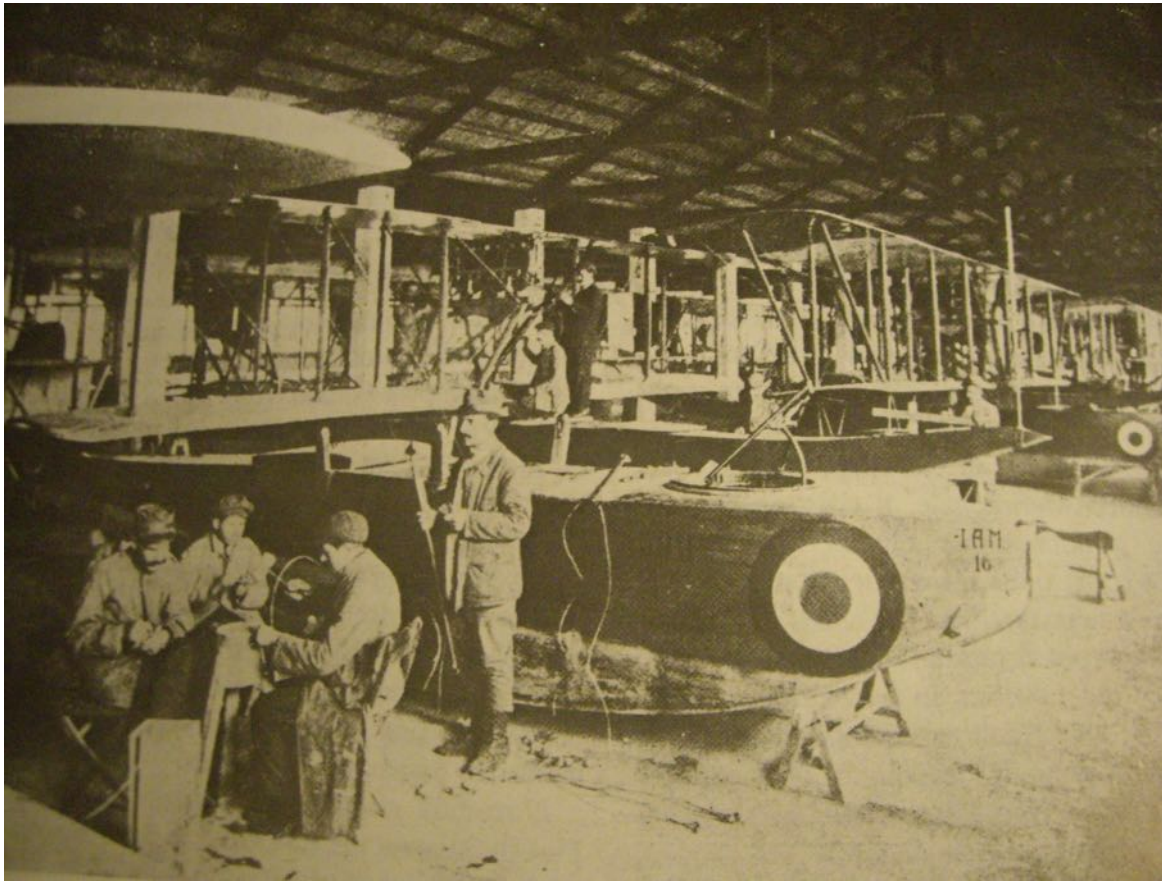

Stabilimento idrovolanti IAM  
Baia 1916

# Un Secolo del Settore Aeronautico Campano. Una storia poco conosciuta.



**Nicola Romeo**

IAR Industrie Aeronautiche  
Romeo 1917

OFM Officine Ferrovarie  
Meridionali



**Umberto Nobile**  
**(Delle Piane)**

Università di Napoli 1926  
Norvegia 1926  
Italia 1928





Un Secolo del Settore Aeronautico Campano.  
Una storia poco conosciuta.



**Gen. Giulio Douhet**  
(1921 – Il Dominio dell’Aria)



**Francesco De Pinedo**  
(1927 – Raid aereo in Nord e  
Sud America)

# Un Secolo del Settore Aeronautico Campano. Una storia poco conosciuta.



## Accademia dell'Aeronautica Militare Italiana



Caserta (1926-1943)  
Nisida (1945 – 1961)  
Pozzuoli ( from 1961)



# Un Secolo del Settore Aeronautico Campano. Una storia poco conosciuta.

OFM - IMAM

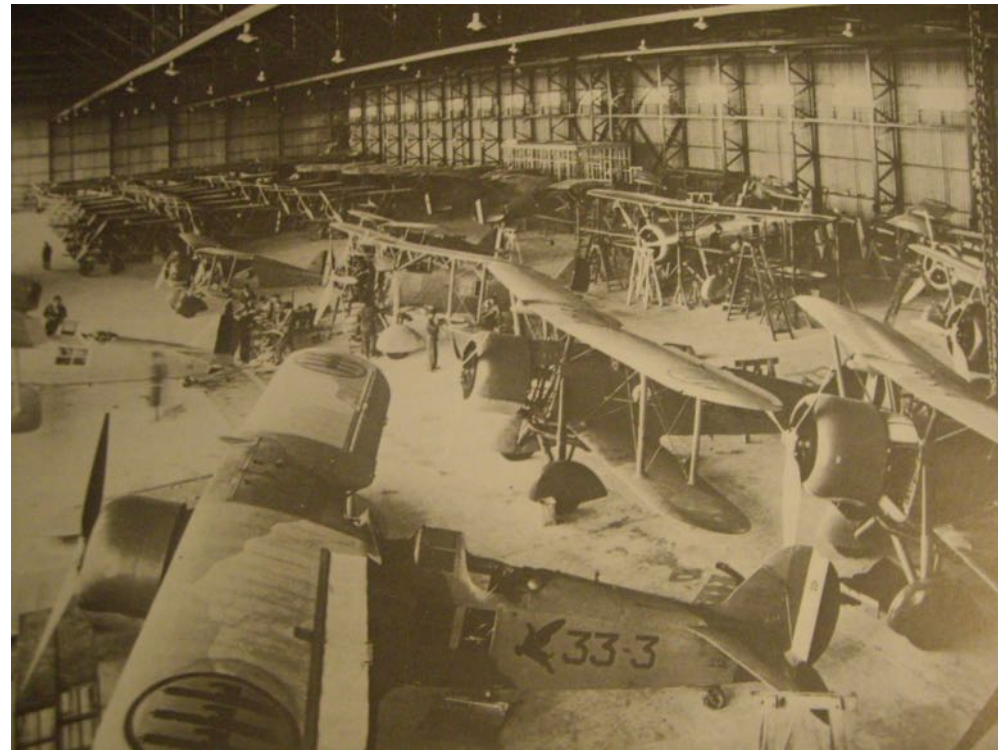

Un Secolo del Settore Aeronautico Campano.  
Una storia poco conosciuta.  
IMAM





Un Secolo del Settore Aeronautico Campano.  
Una storia poco conosciuta.  
IMAM

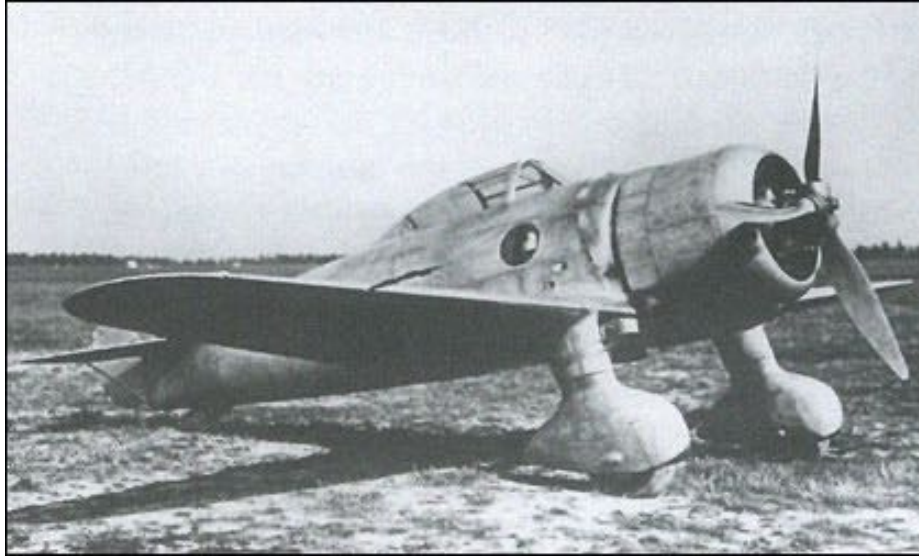



# Un Secolo del Settore Aeronautico Campano. Una storia poco conosciuta.



1 Aprile 1939

Posa prima pietra  
Stabilimento Pomigliano

1 Aprile 1940

Prodotti primi 8 motori  
AR 115

corriere di NAPOLI

**MUSSOLINI PONE LA PRIMA PIETRA**  
dello Stabilimento Aeronautico fra Pomigliano d'Arco e Acerra  
La parola del Duce esalta gli animi delle Camicie Nere di Capua

Fra imponenti manifestazioni di entusiastica fede del Fascismo Campano il Fondatore dell'Impero inizia i lavori di appoderamento della zona di bonifica del Volturmo, nuova opera costruttiva di pace dell'Era Littoria



**La prima pietra**



NAPOLI. - DI RITORNO DALLA CALABRIA IL DUCE SI E' RECATO PRESSO NAPOLI FRA ACERRA E POMIGLIANO D'ARCO A PORRE LA PRIMA PIETRA DOVE SORGERA' IL GRANDIOSO STABILIMENTO DI COSTRUZIONI AERONAUTICHE.

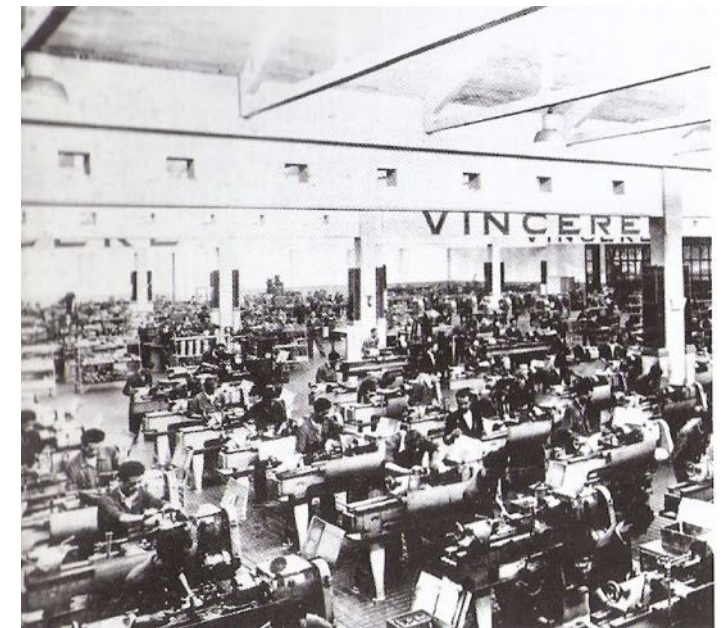



# Un Secolo del Settore Aeronautico Campano. Una storia poco conosciuta.

## Pomigliano



PISTA DI VOLO POMIGLIANO D'ARCO 1941  
VELIVOLO MACCHI 202 FOLGORE MOTORE RA1000 R.C. 41-1





# Un Secolo del Settore Aeronautico Campano. Una storia poco conosciuta.

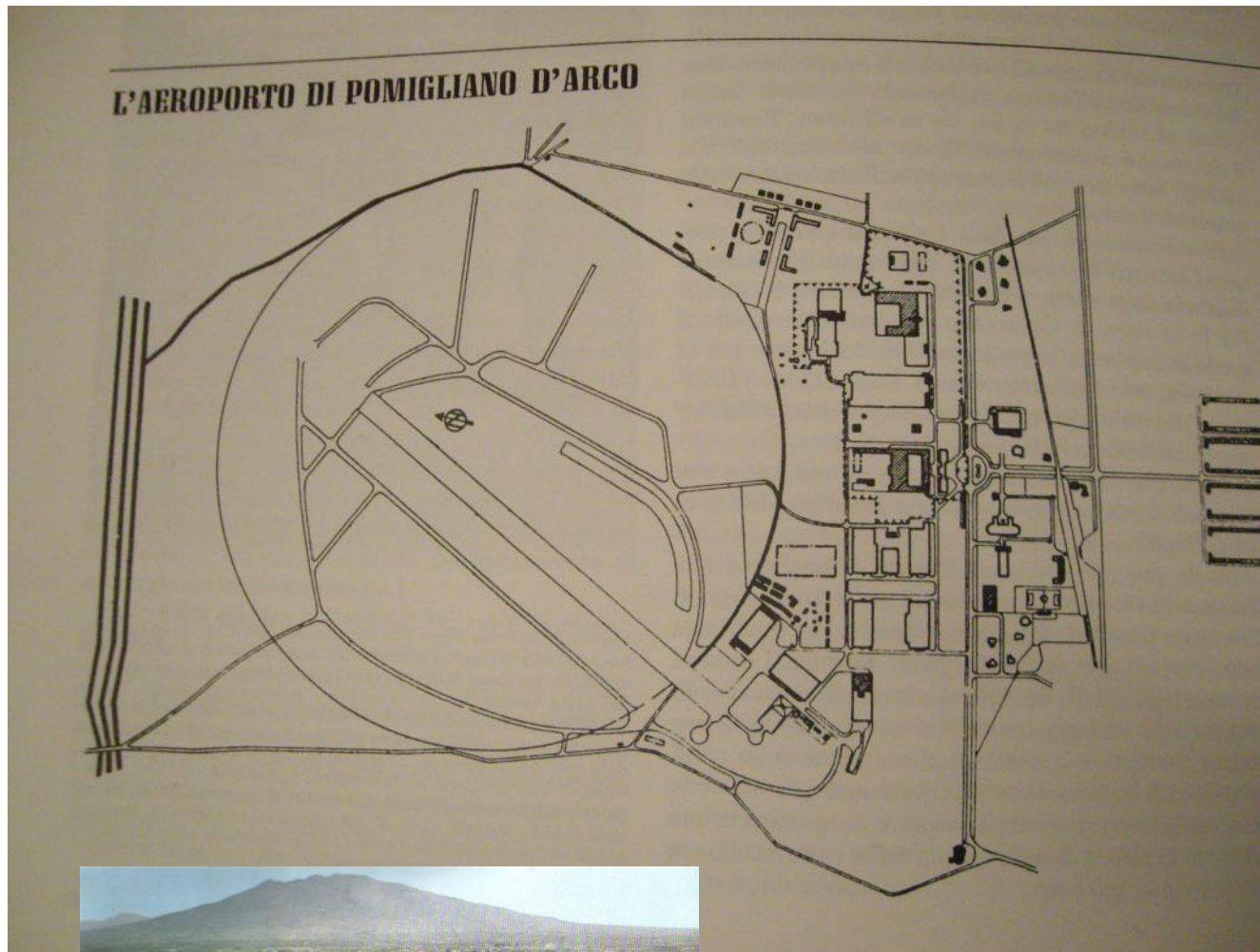

Pomigliano

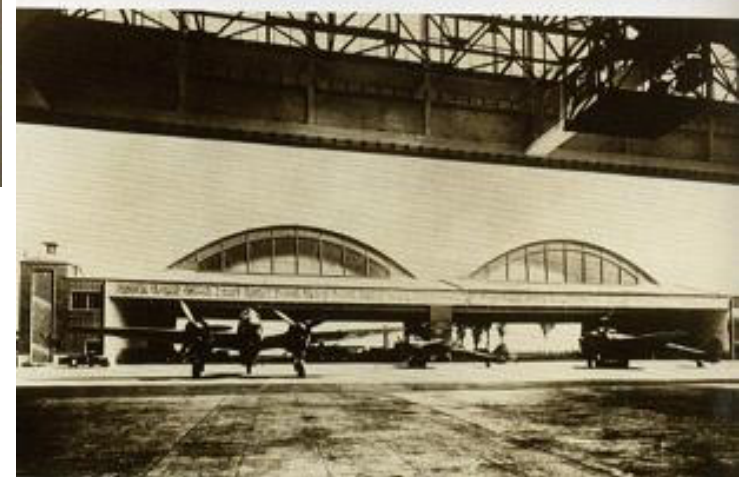



# Un Secolo del Settore Aeronautico Campano. Una storia poco conosciuta.

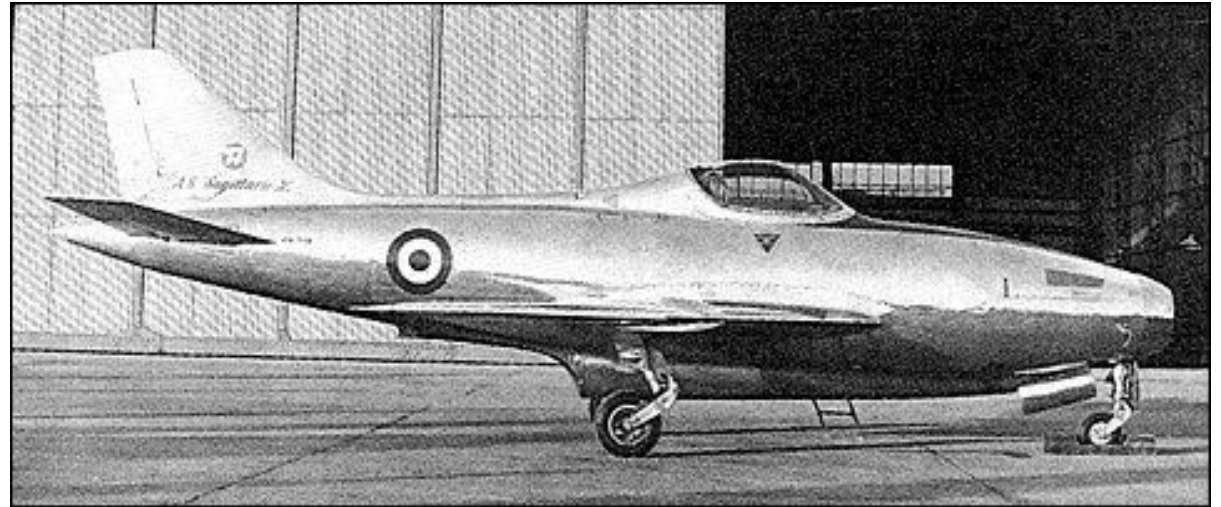

1956  
Sagittario  
Aerfer (now Alenia)



Un Secolo del Settore Aeronautico Campano.  
Una storia poco conosciuta.

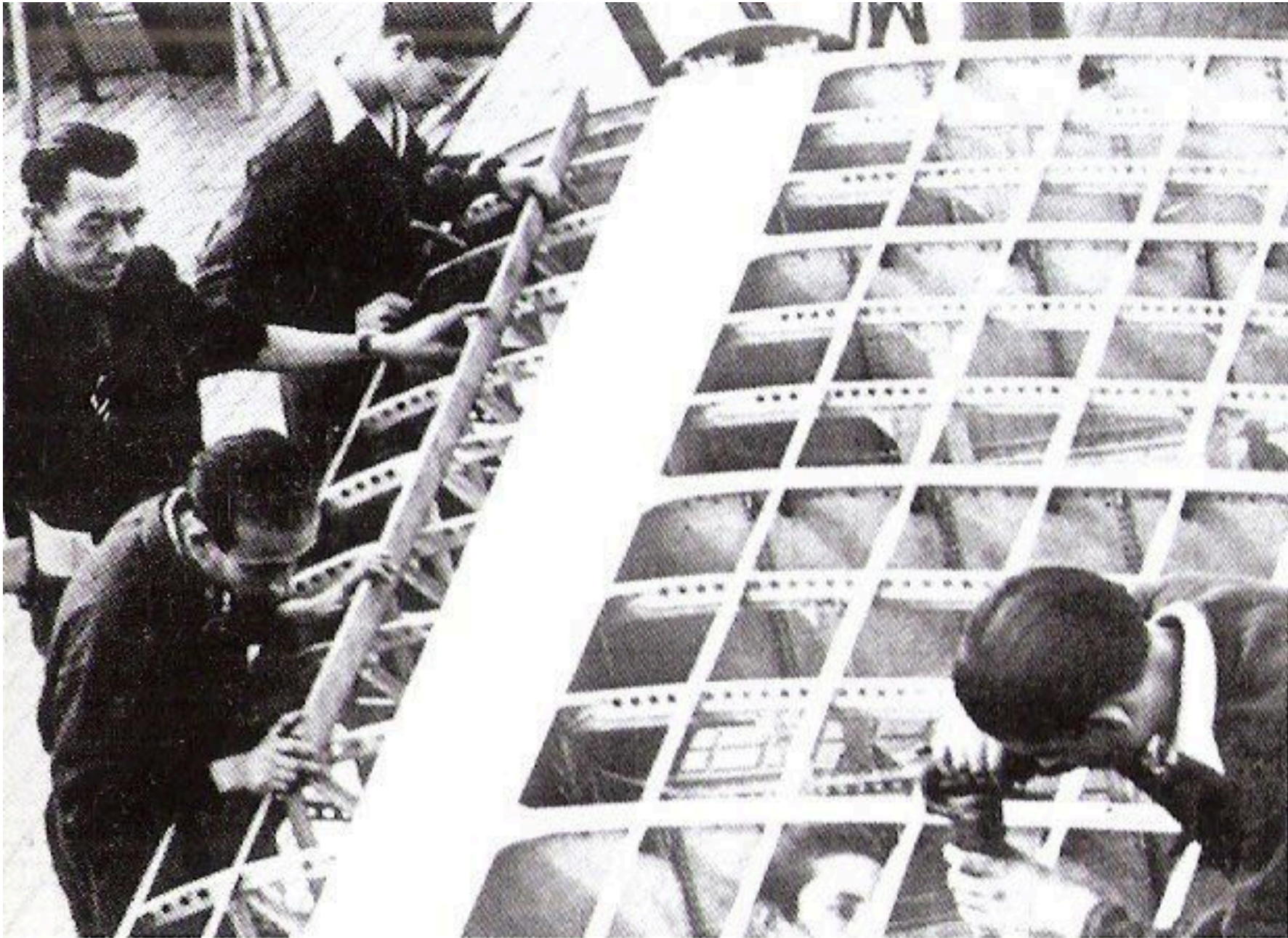

Aerfer



# Un Secolo del Settore Aeronautico Campano. Una storia poco conosciuta.



Aerfer  
(ora Alenia)





# Un Secolo del Settore Aeronautico Campano. Una storia poco conosciuta.



Aerfer  
(ora Alenia)





# Un Secolo del Settore Aeronautico Campano. Una storia poco conosciuta.



Ing. RENATO BONIFACIO  
Aeritalia  
( ora Alenia Aermacchi)

# Un Secolo del Settore Aeronautico Campano. Una storia poco conosciuta.



Mc Donnell Douglas  
DC 9



Mc Donnell Douglas  
DC 10



Boeing 767



Un Secolo del Settore Aeronautico Campano.  
Una storia poco conosciuta.



G 222 - Spartan C27J

Un Secolo del Settore Aeronautico Campano.  
Una storia poco conosciuta.



ATR 42/72



# Un Secolo del Settore Aeronautico Campano. Una storia poco conosciuta.



Alenia Aermacchi

collabora con

Boeing

Airbus

Bombardier



# Un Secolo del Settore Aeronautico Campano. Una storia poco conosciuta.

## Alfa Romeo



## Avio

Stabilimento di Pomigliano

- Pomigliano d'Arco plant, Italy



Un Secolo del Settore Aeronautico Campano.  
Una storia poco conosciuta.



SELEX ES

# Un Secolo del Settore Aeronautico Campano. Una storia poco conosciuta.



**MBDA**

MISSILE SYSTEMS



# **Un Secolo del Settore Aeronautico Campano. Una storia poco conosciuta.**

## **Il settore aerospaziale campano:**

- 29 aziende con “core business ”nell’aerospazio**
- 130 aziende della supply chain**
- 10.000 addetti**
- Fatturato di circa 2 miliardi di euro .**

**La Campania rappresenta circa il 25% del settore aerospaziale italiano con specializzazione sulle aerostutture ad ala fissa di aviazione civile.**

# Un Secolo del Settore Aeronautico Campano. Una storia poco conosciuta.

Alenia Aermacchi

Abete

Atitech

Avio

Compagnia Generale dello Spazio -CGS

CMD

Dema

EMA Europea Microfusioni Aerospaziali

Geven

Laer

Magnaghi Aeronautica

Marotta

Mecfond

MTA

Oma Sud

Selex ES

Tecnam

Vulcanair



# Un Secolo del Settore Aeronautico Campano. Una storia poco conosciuta

- Consorzio CHAIN
- Consorzio Technapoli
- Società Aerospaziale Mediterranea (SAM)
- Consorzio A.L.I.
- Consorzio Caltec
- Consorzio Napoli Est
- Consorzio TPC Group

# Un Secolo del Settore Aeronautico Campano. Una storia poco conosciuta.



Horizontal Stabilizer ATR 42



Bulkhead B787 (titanium)



Autoclave

*DEMA*



# Un Secolo del Settore Aeronautico Campano. Una storia poco conosciuta.

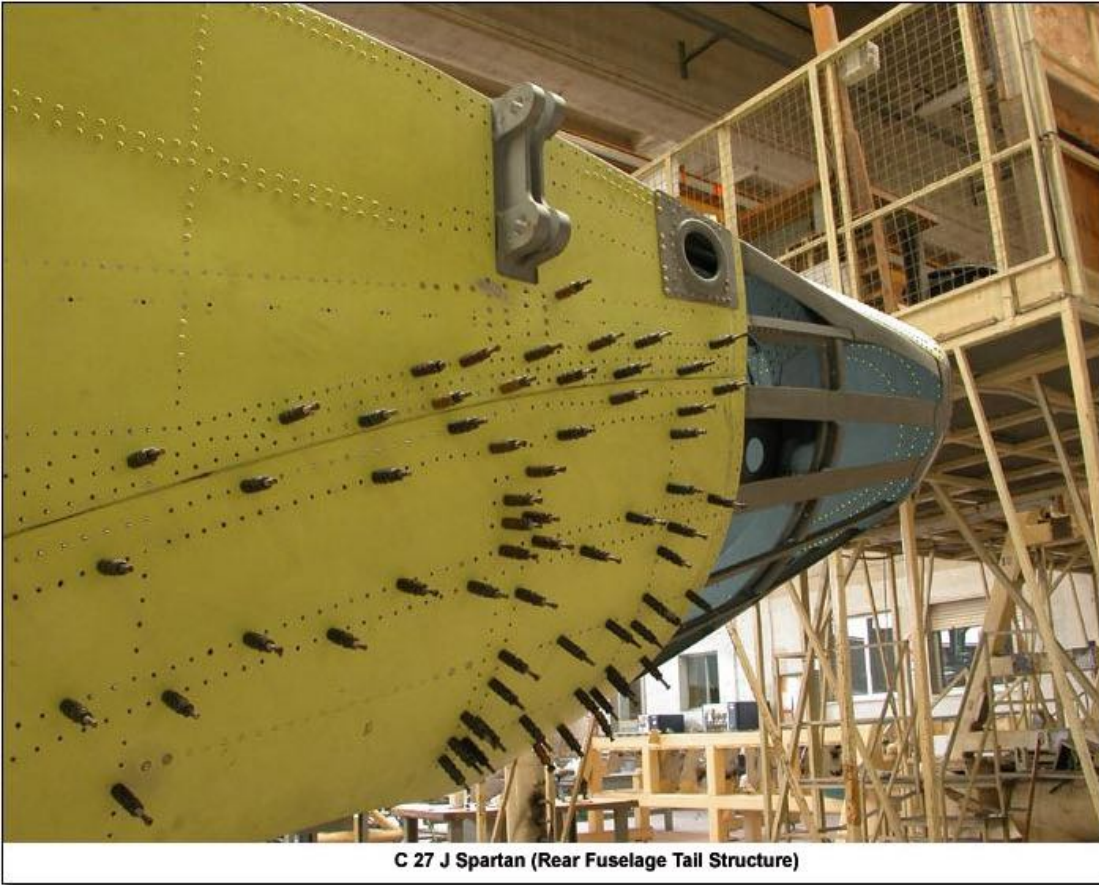

C 27 J Spartan (Rear Fuselage Tail Structure)

**LAER**



ATR42/72 15th sec. (Upper side panels)

Un Secolo del Settore Aeronautico Campano.  
Una storia poco conosciuta.

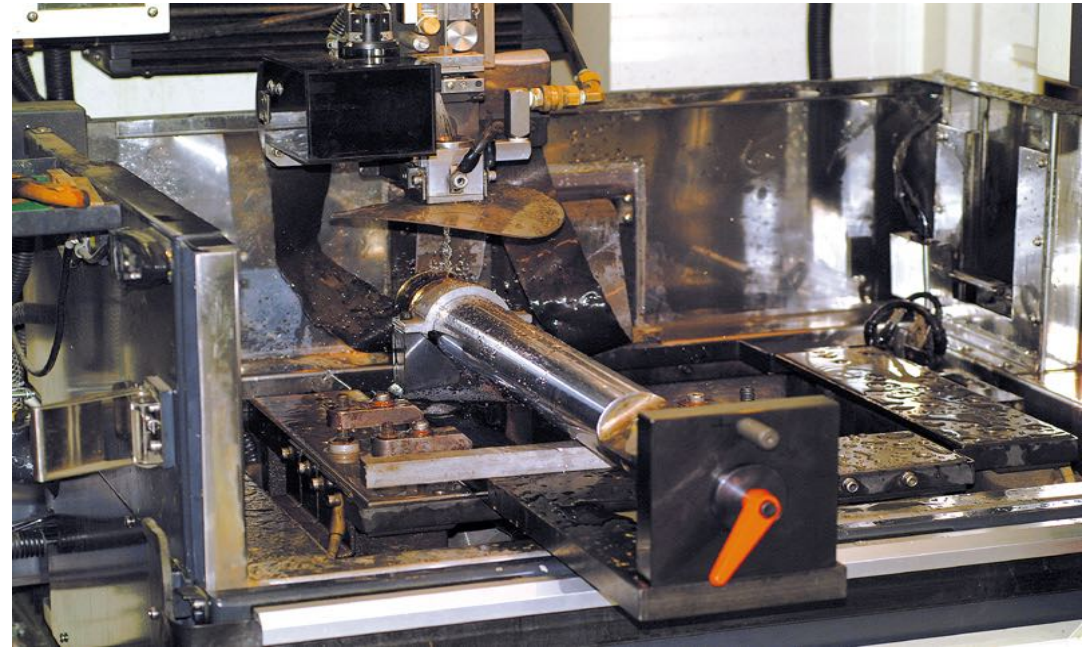
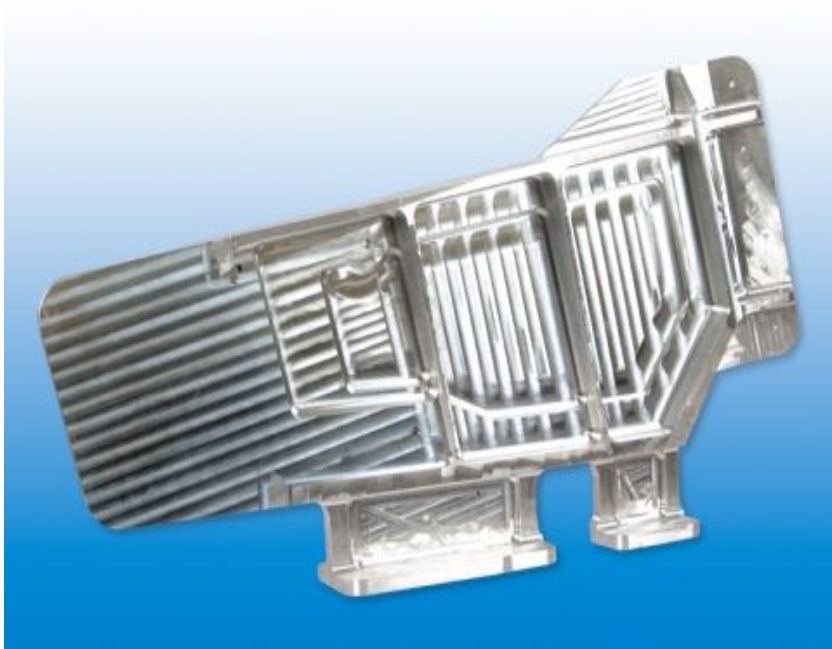

*ABETE*



# Un Secolo del Settore Aeronautico Campano. Una storia poco conosciuta.



**ATR42 Carrello principale**  
**ATR42 Main landing gear**



**C27J - Nose Landing Gear**

## Magnaghi Aeronautica

# Un Secolo del Settore Aeronautico Campano. Una storia poco conosciuta.



V. LA GATTA



Un Secolo del Settore Aeronautico Campano.  
Una storia poco conosciuta.

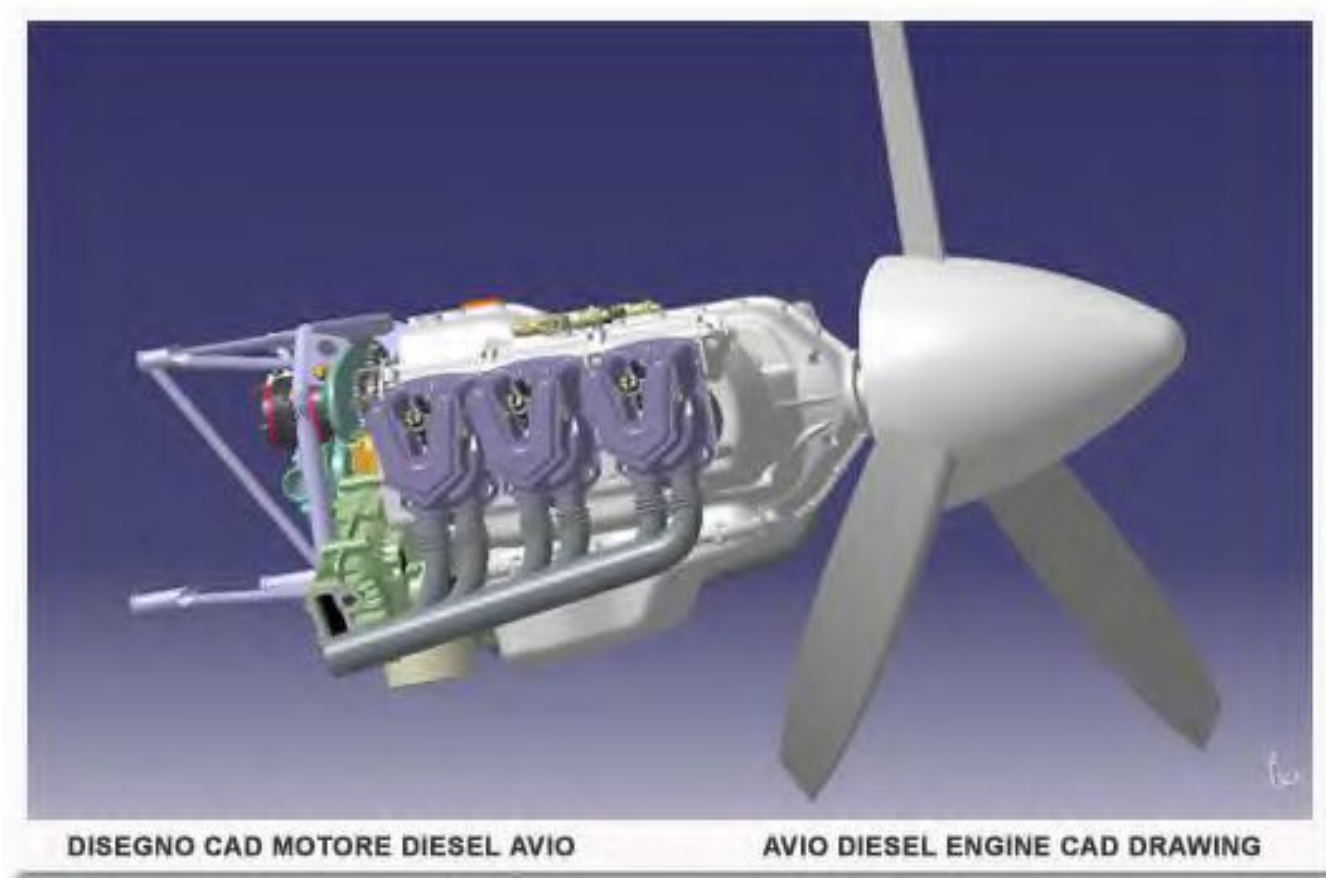

CMD

Un Secolo del Settore Aeronautico Campano.  
Una storia poco conosciuta.



EMA

Europea Microfusioni Aerospaziali



Un Secolo del Settore Aeronautico Campano.  
Una storia poco conosciuta.



*GEVEN (interiors)*

Un Secolo del Settore Aeronautico Campano.  
Una storia poco conosciuta.



TI&A





# Un Secolo del Settore Aeronautico Campano. Una storia poco conosciuta.

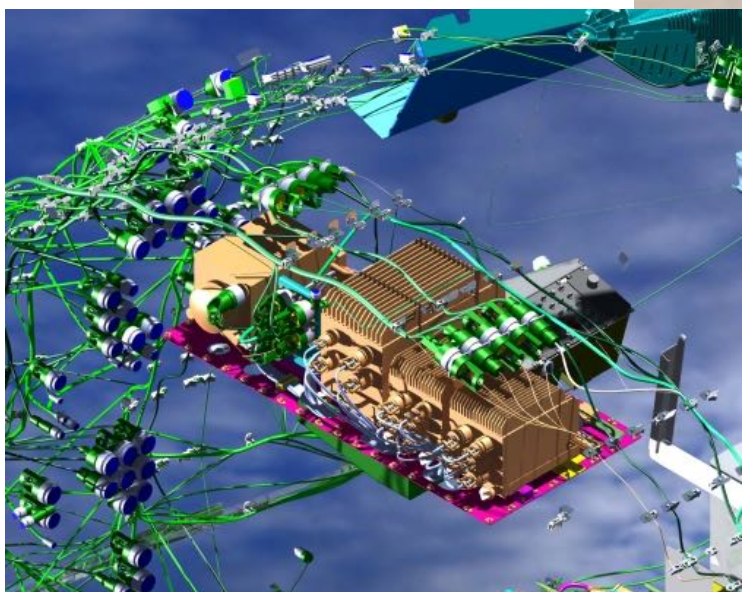
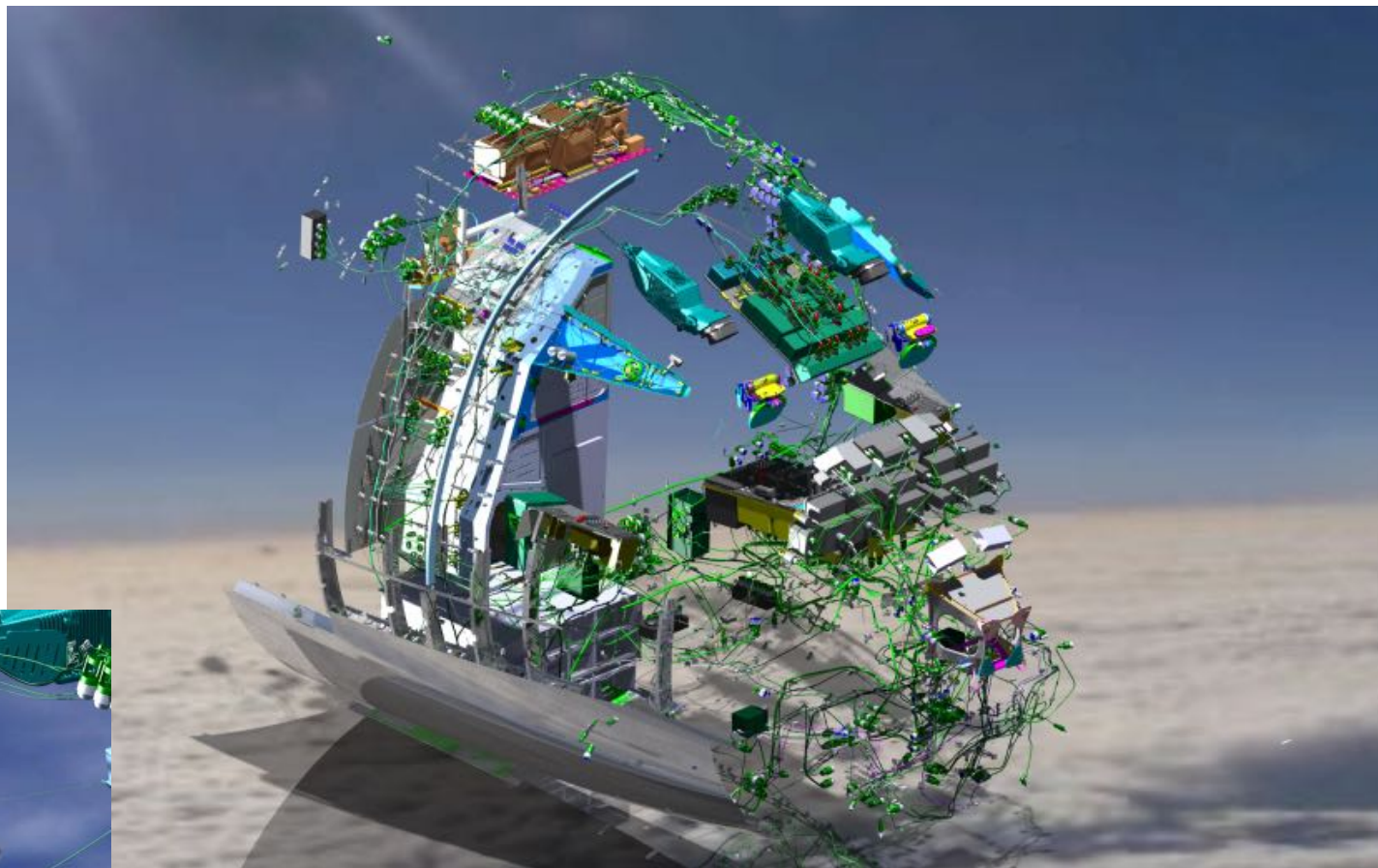

Desà

Un Secolo del Settore Aeronautico Campano.  
Una storia poco conosciuta.

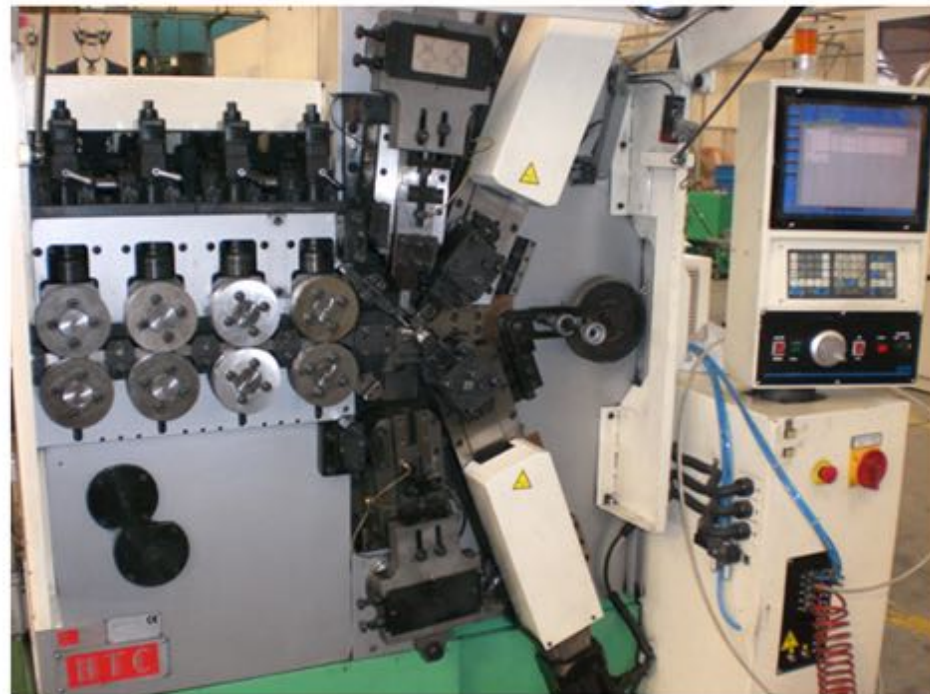

NUOVO MOLLIFICIO CAMPANO



# Un Secolo del Settore Aeronautico Campano. Una storia poco conosciuta.



## MECFOND

Stretch forming machine - VS 500 model - Alenia

Nola (NA)



Automatic Guided Vehicle for heavy tools  
handling - 120 T Model – Alenia

Aeronautica Grottaglie (TA)

Un Secolo del Settore Aeronautico Campano.  
Una storia poco conosciuta.



**Cabina di verniciatura (Programma EFA) -- Painting cabin (EFA Program)**

**NADDEO**



Un Secolo del Settore Aeronautico Campano.  
Una storia poco conosciuta.



*ATITECH*  
*(heavy maintenance services)*

Un Secolo del Settore Aeronautico Campano.  
Una storia poco conosciuta.



M.T.A.  
( maintenance services)



# Un Secolo del Settore Aeronautico Campano. Una storia poco conosciuta.



& aXitude



# Un Secolo del Settore Aeronautico Campano. Una storia poco conosciuta.



Assessorato all'Agricoltura  
e alle Attività Produttive

*some airplanes  
made in Campania*

*Costruzioni aeronautiche Tecnam srl*



*Oma Sud spa*



*Vulcanair spa*

## Aviazione Generale

# Un Secolo del Settore Aeronautico Campano. Una storia poco conosciuta.



Luigi e Giovanni  
Pascale

Partenavia





# Un Secolo del Settore Aeronautico Campano. Una storia poco conosciuta.



**Vulcanair**  
certification JAR 147 “Approved  
Maintenance Training/Examination”



# Un Secolo del Settore Aeronautico Campano. Una storia poco conosciuta.



## Costruzioni Aeronautiche Tecnam



# Un Secolo del Settore Aeronautico Campano. Una storia poco conosciuta.



Oma Sud





# Un Secolo del Settore Aeronautico Campano. Una storia poco conosciuta.



Airmark

Sab Aviation

SAI



Un Secolo del Settore Aeronautico Campano.  
Una storia poco conosciuta.



*Piaggio Aero Cento R&D  
(Arco Felice)*

# Un Secolo del Settore Aeronautico Campano. Una storia poco conosciuta.



K4A





# Un Secolo del Settore Aeronautico Campano. Una storia poco conosciuta.



Programma San Marco (Luigi Broglio)  
vettore Vega

Un Secolo del Settore Aeronautico Campano.  
Una storia poco conosciuta.



CGS -Compagnia  
Generale della Spazio  
(Satelliti)

# Un Secolo del Settore Aeronautico Campano. Una storia poco conosciuta.



## MARS – TELESPAZIO

space remote control



Un Secolo del Settore Aeronautico Campano.  
Una storia poco conosciuta.

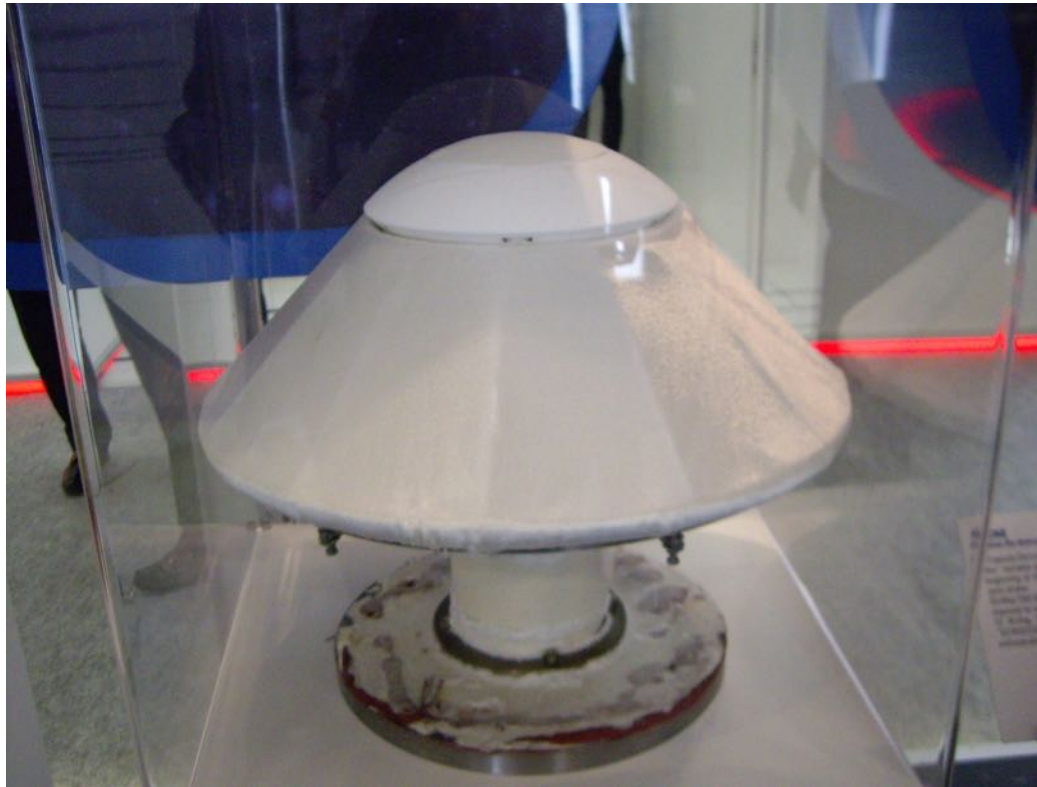

**IRENE**

**(Italian Re-Entry Nacelle)**

**Ali -Aerospace Laboratory for Innovative Components-**

**ASI**

# Un Secolo del Settore Aeronautico Campano. Una storia poco conosciuta.

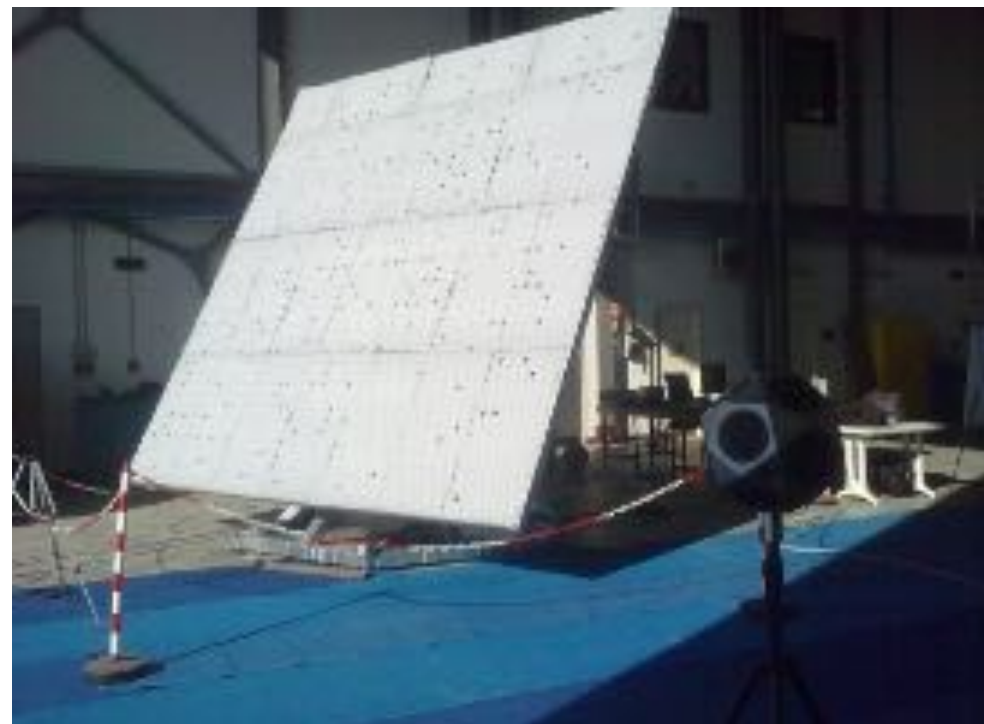

# Un Secolo del Settore Aeronautico Campano. Una storia poco conosciuta.



e-voluzione



FOX BIT

alTran  
ITALIA



OMP

engineering - design – analysis –tests -measurement



Un Secolo del Settore Aeronautico Campano.  
Una storia poco conosciuta.

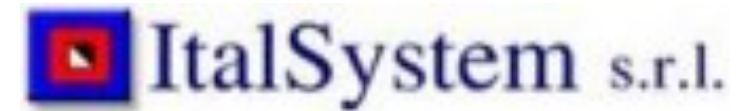

electronics - software

# Un Secolo del Settore Aeronautico Campano. Una storia poco conosciuta.



productions - interiors— treatments - services



Impossibile visualizzare l'immagine. La memoria del computer potrebbe essere insufficiente per aprire l'immagine oppure l'immagine potrebbe essere danneggiata. Riavviare il computer e aprire di nuovo il file. Se viene visualizzata di nuovo la x rossa, potrebbe essere necessario eliminare l'immagine e inserirla di nuovo.

# Un Secolo del Settore Aeronautico Campano. Una storia poco conosciuta.



DIAS – Dipartimento di Ingegneria Aerospaziale  
Università di Napoli – Federico II

**Prof. Luigi Napolitano**



**Prof. Luigi Pascale**

(fondatore anche della Partenavia e della Tecnam)



Un Secolo del Settore Aeronautico Campano.  
Una storia poco conosciuta.

- DIAS Dipartimento di Ingegneria Aerospaziale –  
Federico II - Napoli
- SUN – Seconda Università di Napoli
- Unisannio
- Università di Salerno
- Università Pathenope - Napoli

# Un Secolo del Settore Aeronautico Campano. Una storia poco conosciuta.

<b>CIRA</b>	<b>Italian Aerospace Research Center</b>
<b>CARN</b>	<b>Campania Aerospace Research Network</b>
<b>IMM</b>	<b>Institute of Microelectronics and Microsystems CNR</b>
<b>TEST</b>	<b>Technology Environment Safety Transport</b>
<b>IMAST</b>	<b>Technological District on Engineering of Polymer and Composite Materials and Structures</b>
<b>MARS CENTER</b>	<b>Microgravity Advanced Research and Support Center</b>



# Un Secolo del Settore Aeronautico Campano. Una storia poco conosciuta.

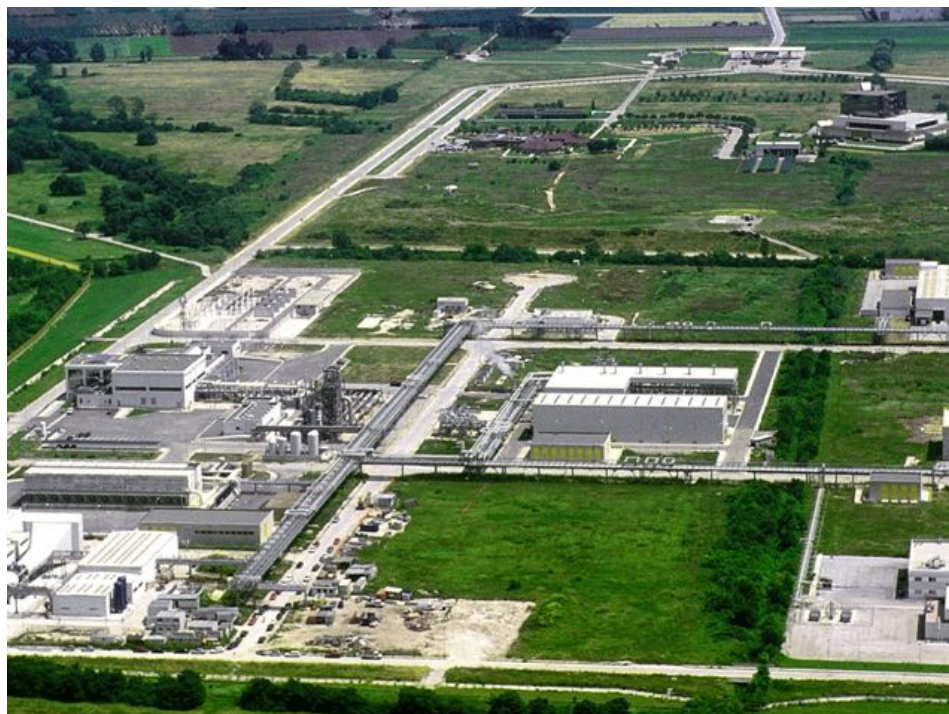



# Un Secolo del Settore Aeronautico Campano. Una storia poco conosciuta.

## USV-Unmanned Space Vehicle



# IAC International Astronautic Congress



## NAPLES FOR IAC 2012

63<sup>a</sup> edizione del Congresso  
Internazionale  
dell'Astronautica (Iac)



COMUNE DI NAPOLI







Il volume ricostruisce un secolo di storia del settore aeronautico e spaziale campano con una finalità di divulgazione rivolta anche ai non addetti ai lavori. L'idea è nata dalla constatazione dell'autore che, approfondendo la realtà del settore per motivi di lavoro e per passione personale, si è reso conto che la conoscenza di tale eccellenza della Campania non solo è poco diffusa nell'opinione pubblica, ma talvolta è frammentaria anche tra gli operatori del settore. La storia del settore aerospaziale campano, specializzatosi negli anni prevalentemente in aerosturture per l'ala fissa civile e in velivoli di aviazione generale, dimostra come anche nel sud Italia si possano sviluppare eccellenze di assoluto rilievo, smentendo i luoghi comuni negativi ed evidenziando le capacità tecniche e manageriali esistenti nel Mezzogiorno. Pertanto, anche gli investimenti pubblici fatti nel passato in tale settore sono stati ripagati dallo sviluppo economico e sociale che hanno generato nelle aree interessate e dalle competenze sviluppate dai progettisti, dagli ingegneri e dalle maestranze campane, che spesso sono molto più apprezzate e conosciute all'estero che non nel territorio di origine.



**Sergio Mazzarella**, laureato in giurisprudenza, avvocato e specializzato in diritto amministrativo, dopo aver frequentato la Scuola Superiore della Pubblica Amministrazione e aver ricoperto incarichi di funzionario pubblico in vari ministeri, a seguito di superamento di concorsi pubblici, è dirigente della Regione Campania e si occupa di attività produttive. Nell'ambito di tale funzione, ha ideato e sviluppato l'iniziativa "Campaniaerospace" volta a sostenere lo sviluppo e la promozione del settore aerospaziale campano e a favorire la crescita di reti di impresa, anche attraverso l'attivazione di un accordo di programma tra la Regione Campania e il Cira. Per tale iniziativa, su segnalazione delle aziende del settore, nel 2008 è stato premiato a livello nazionale quale finalista dal "Forum della Pubblica Amministrazione".

Sergio Mazzarella



# UN SECOLO DEL SETTORE AERONAUTICO CAMPANO

Una storia poco conosciuta



# Grazie per l'attenzione